

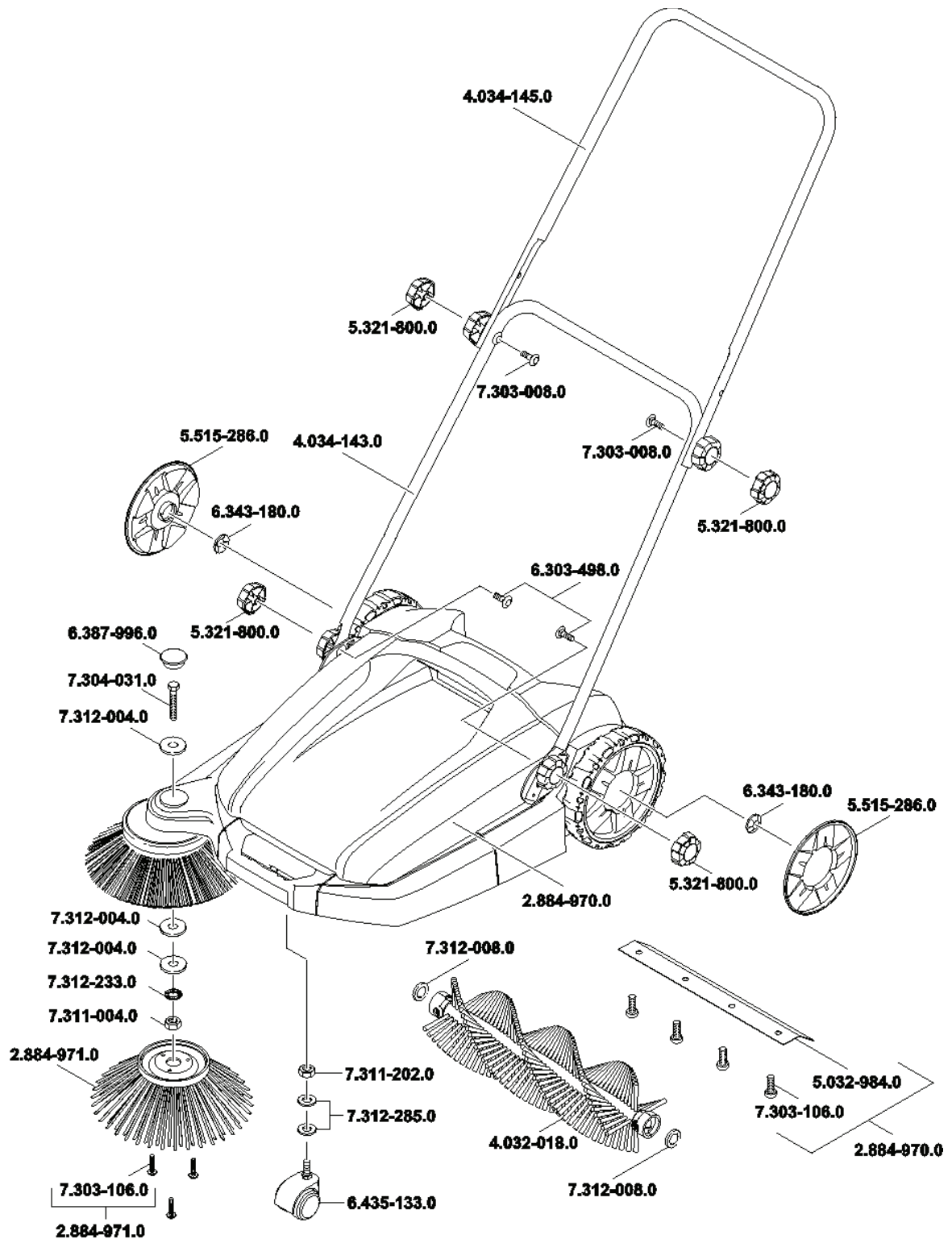



KÄRCHER S 550

1.766-200

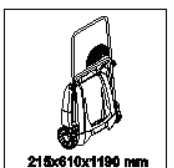
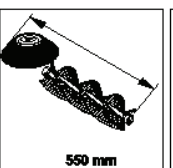
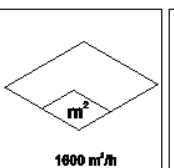
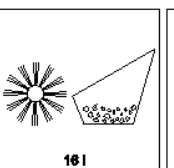
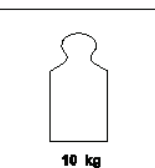

 690x618x830 mm	 215x610x1190 mm	 350 mm	 550 mm	 1600 m ² /h	 18 l	 10 kg
---	--	---	---	--	---	--